

# 1029D

## Single-Phase Phase Angle SCR Power Controller

### FEATURES

- Phase-Angle Control
- Linear control of RMS Voltage, RMS Current or Load power with respect to a command signal independent of line voltage variations
- Adjustable Current Limit
- Adjustable Over Current Trip
- Shorted SCR Detection
- Soft Start with Missing Cycle Detection
- Run & Idle Command Inputs
- Operates at 50 or 60 Hz
- Output signals representing load current and voltage
- Plug-In & Interchangeable Circuit Card
- Diagnostic/Status LEDs
- Optical Coupled Gatedrives
- Over Temp Protection (T-Stat on Heat Sink)



LISTED 3L32  
INDUSTRIAL  
CONTROL  
EQUIPMENT  
E136219



CERTIFIED  
BY UL TO  
CANADIAN  
NATIONAL  
STANDARDS



### APPLICATIONS

- Variable Resistance Loads
  - Silicon Carbide
  - Molybdenum Disilicide
  - Graphite
- T-3 Lamps
- Transformer Coupled Loads
- Fast Responding Loads

### DESCRIPTION

The model 1029D is a single phase, phase-angle SCR power controller. The controller linearly controls, with respect to a command signal, either the RMS value of the load voltage, the average value of the load voltage, the RMS load current or load power. The controller can be configured to accept all standard industrial command signals as well as many non-standard commands.

The model 1029D is available with current ratings from 50 to 750 amperes, and nominal voltage ratings from 120 to 575 Vac. The controller will operate without adjustment or modification on 50 or 60 Hertz.

1000 and 2000 amp units, although not UL listed, are available, consult factory. The model 1029D is intended for controlling transformer coupled loads, fast responding loads, and non-linear loads such as tungsten, silicon carbide, and molybdenum disilicide.

# DESCRIPTION, CONTINUED

# WIRING

### Current Limiting

Current limiting prevents the load current from exceeding a preset, user adjustable, value. This feature can prevent loads with low cold resistance from drawing excessive startup current. Current limiting can also be used to limit the maximum power applied to a load.

### Over Current Trip

The over current trip provides an adjustable means to remove power when a load fault occurs. The over current trip feature, in the event of excessive current, prevents the SCRs from being turned ON and energizes a relay with form "C" contacts. The relay contacts can be used to activate an alarm or remove system power. The over current trip is preset at 150% of the current rating of the controller. The relay and operation of the controller is reset by momentary closure of a remote contact or by removing power from the controller.

### Shorted SCR Detection

A relay with form "C" contacts is energized in the event an SCR fails in the ON state allowing full power to be continuously applied to the load. The relay contacts can be used to activate an alarm or to cause system power to be removed.

### Soft Start

Soft Start sets the output to zero on startup or after a momentary power interruption and then ramps the output to the desired level at a predetermined rate.

### Run & Idle Input Command Signal Selection.

Closure of a remote contact changes control from the IDLE command input to the RUN command input. This provides a convenient method of switching from auto to manual or from a RUN condition to an IDLE condition.

### Reset.

Momentary closure of a remote contact resets the controller and Over Current Trip relay. Soft Start is initiated. The Reset input may also be used as a Run/Stop control input.

### Optically Coupled SCR Gate Drives.

Optically coupled SCR gate drives provide superior transient immunity and electrical isolation rather than conventional techniques using pulse transformers. This technique virtually eliminates false operation and prevents SCR failure that can result when SCRs are not properly gated into the on state.

### Metering Outputs for Load Voltage, Load Current or Power.

A 0 to 5 Vdc signal proportional to the RMS value of the load voltage and a 0 to 5 Vdc signal proportional to the RMS value of the load current are provided for monitoring the controller output. A 4 to 20mA metering output proportional to RMS load power is a factory option.

### Diagnostic LEDs

The diagnostic/status indicating LEDs provide a convenient and safe method of analyzing the operation of the controller.

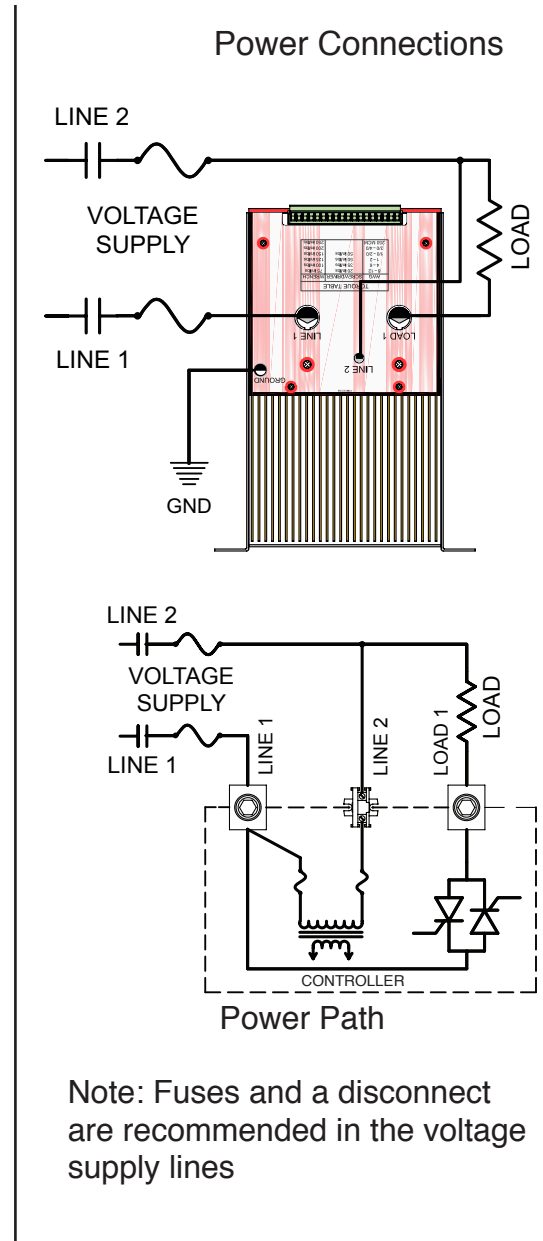

# DIMENSIONS

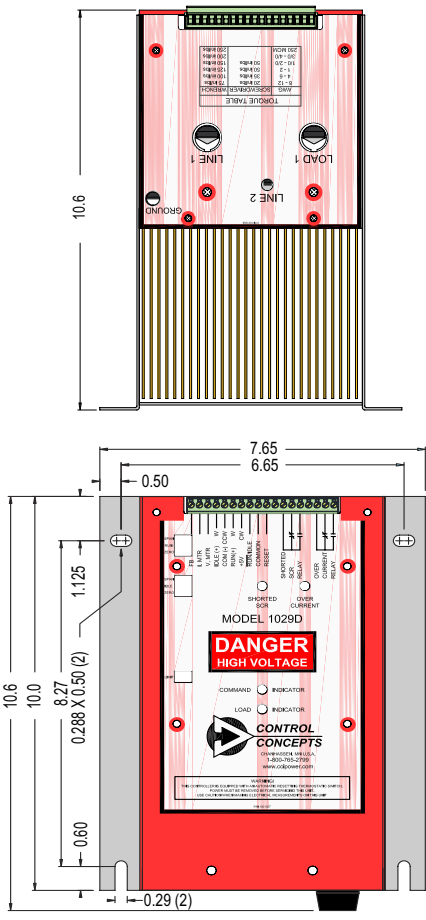

50, 80, 120 & 160 Amps

50 & 80 Amp units are convection cooled and must be mounted so that the heatsink fins are vertical.

The 120 & 160 Amp units are fan cooled and may be mounted in any direction.

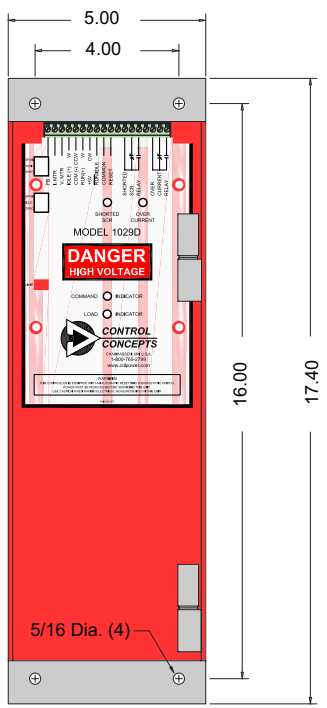
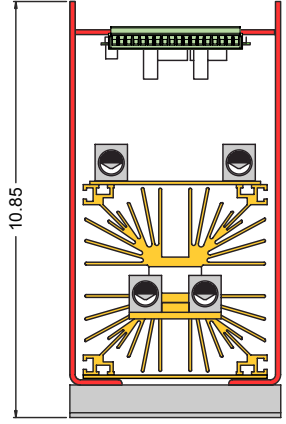

The 200, 250, 300, 380 & 425 Amp units are fan cooled and may be mounted in any direction.

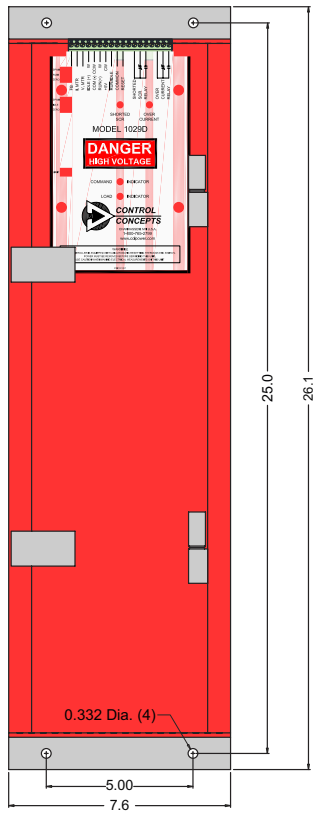
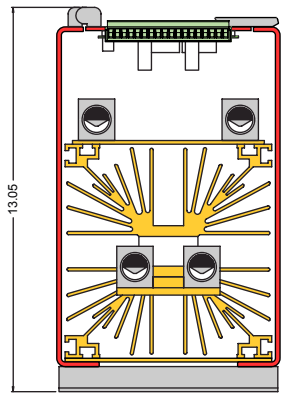

The 500, 600 & 750 Amp units are fan cooled and may be mounted in any direction.

### LUG / WIRE SIZE

Frame Size Amps	Number of Lugs	Recommended Wire Size
50-160	2	6ga-250MCM
200-425	4	6ga-250MCM
500 - 750	4	1/0ga-500MCM

### FIELD WIRING OF CARD CONNECTOR

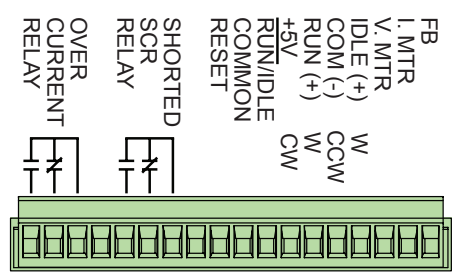

# SPECIFICATIONS

<b>Control Mode(s)</b>	Single-phase, phase angle control of RMS voltage, RMS current, average voltage or power applied to the load. External feedback control is also available.	<b>Line Voltage</b>	120, 240, 480, and 575 Vac, +10%, -15%, 50/60 Hz. Other voltages available.								
<b>Command Signal</b>	<table border="0"> <tr> <td>Signal</td> <td>Impedance</td> </tr> <tr> <td>0-5Vdc</td> <td>200K Ohms</td> </tr> <tr> <td>1-20K Pot.</td> <td>200K Ohms</td> </tr> <tr> <td>4/20mA</td> <td>300 Ohms</td> </tr> </table>	Signal	Impedance	0-5Vdc	200K Ohms	1-20K Pot.	200K Ohms	4/20mA	300 Ohms	<b>Line/Load Connections</b>	Compression lugs provided for copper wire connections. 50 to 425 Amps 6 ga to 250MCM 500 to 750 Amps 1/0 to 500MCM
Signal	Impedance										
0-5Vdc	200K Ohms										
1-20K Pot.	200K Ohms										
4/20mA	300 Ohms										
<b>Control Range</b>	0 to 98% of line voltage.	<b>Load Current</b>	Models available with current ratings of 50, 80, 120, 160, 200, 250, 300, 380, 425, 500, 600 & 750 (1000 & 2000A, consult factory).								
<b>Linearity</b>	Output is linear within 2% of span over entire range of control.	<b>dv/dt and Transient Voltage Suppression</b>	200 Volts/microsecond minimum. Uses a dv/dt snubber and a metal oxide varistor (MOV).								
<b>Zero and Span</b>	Factory preset.	<b>Cooling</b>	Convection cooling on 50A & 80A units. Forced air fan cooling on all others.								
<b>Current Limit</b>	User adjustable over a range from 20% to 105% of rated current.	<b>Weight</b>	50A and 80A, 16 pounds; 120 and 160A, 17 pounds; 200A thru 425A, 21 pounds; 500A thru 750A, 40 pounds.								
<b>Over Current Trip</b>	Adjustable. LED indication and Form "C" relay contacts for output. Preset at 150% of rated frame current.	<b>Temperature</b>	Operating: 0 to +55 C (+32 to +131 F) Storage: -40 to +80 C (-40 to +176 F)								
<b>Isolation</b>	Dielectric strength, input/output and load voltage/heatsink: 2500V(RMS)	<b>Heat Dissipation</b>	1.5 Watts per amp of controlled current.								
<b>Mounting</b>	Convection cooled: Heatsink fins vertical. Forced air cooled: any orientation.	<b>Fusing</b>	Special semiconductor fuses are not required. Class T fuses are recommended to protect controller and load.								

# ORDERING INFO

**1029D - (X) - (XXX)V - (XXX)A - IL(XXX) - R(XXX) - I(XXX)**

**Model Number** \_\_\_\_\_

**Feedback Type** \_\_\_\_\_

V = RMS Voltage, A = Average Voltage  
I = RMS Current, E = External (0/5 Vdc)  
P = Power

**Operating Voltage** \_\_\_\_\_

120, 208, 240, 277, 380, 415, 480, or 575 Vac.

**Operating Current** \_\_\_\_\_

50, 80, 120, 160, 200, 250, 300, 380, 425, 500, 600 & 750  
(Consult factory for 1000 & 2000 Amps)

**Current Limiting** \_\_\_\_\_

Up to 105% of controller rating.

**Run Command Signal** \_\_\_\_\_

0/5Vdc, 4/20mA or Potentiometer

**Idle Command Signal** \_\_\_\_\_

0/5Vdc, 4/20mA or Potentiometer

## CONTACT/ORDERING INFORMATION

TEL: (952) 474-6200 | (800) 765-2799  
 FAX: (952) 474-6070 | www.cci-power.com  
 18760 Lake Drive East, Chanhassen, MN 55317, USA

